

- Kiinteät lasit 10.8Lp (55.2) tai vastaava R_w 38 dB (suositus)
- Vaihtoehto kiinteät lasit 8.8Lp (44.2) tai vastaava, R_w 37 dB
Kirkas laminoitu
- Umpioivi R_w 37 dB

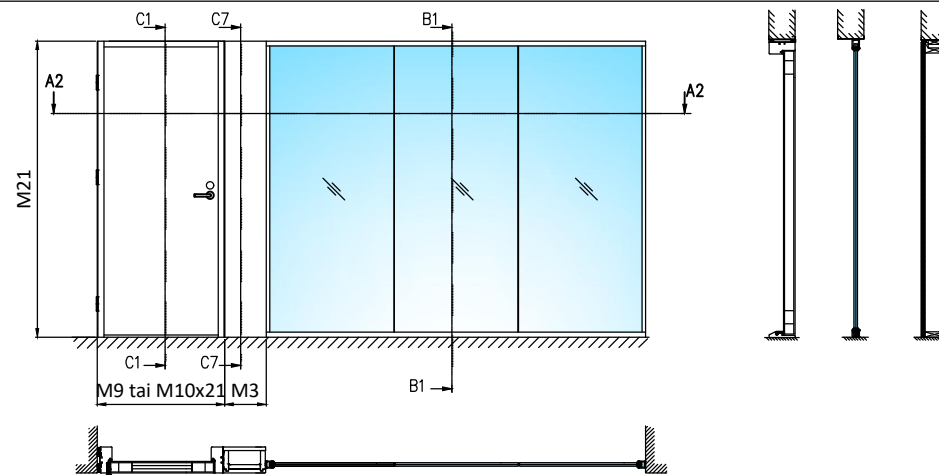

- Kiinteät lasit 10.8Lp (55.2) tai vastaava R_w 38 dB (suositus)
- Vaihtoehto kiinteät lasit 8.8Lp (44.2) tai vastaava, R_w 37 dB
Kirkas laminoitu
- Umpioivi R_w 37 dB

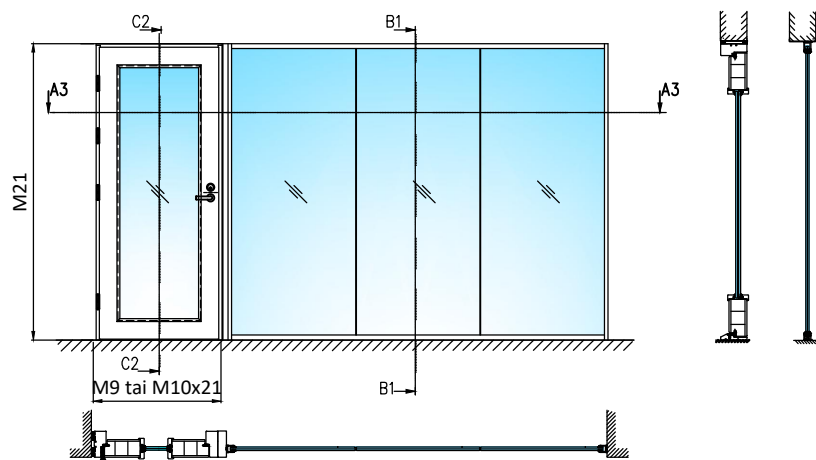

- Kiinteät lasit 10.8Lp (55.2) tai vastaava R_w 38 dB (suositus)
- Vaihtoehto kiinteät lasit 8.8Lp (44.2) tai vastaava, R_w 37 dB
Kirkas laminoitu
- Lasiukollinen ovi R_w 37 dB

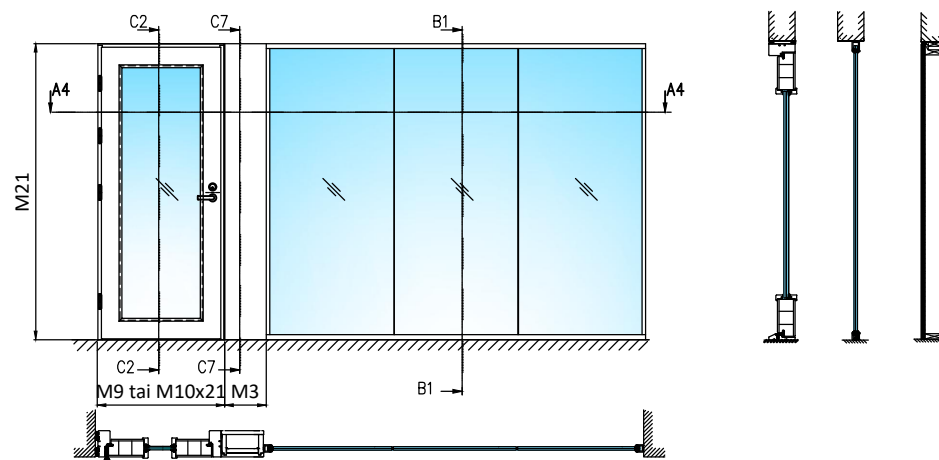

- Kiinteät lasit 10.8Lp (55.2) tai vastaava R_w 38 dB (suositus)
- Vaihtoehto kiinteät lasit 8.8Lp (44.2) tai vastaava, R_w 37 dB
Kirkas laminoitu
- Lasiukollinen ovi R_w 37 dB

HUOM! Karmi- ja kynnysvaihtoehdot esitetty detaljeissa!

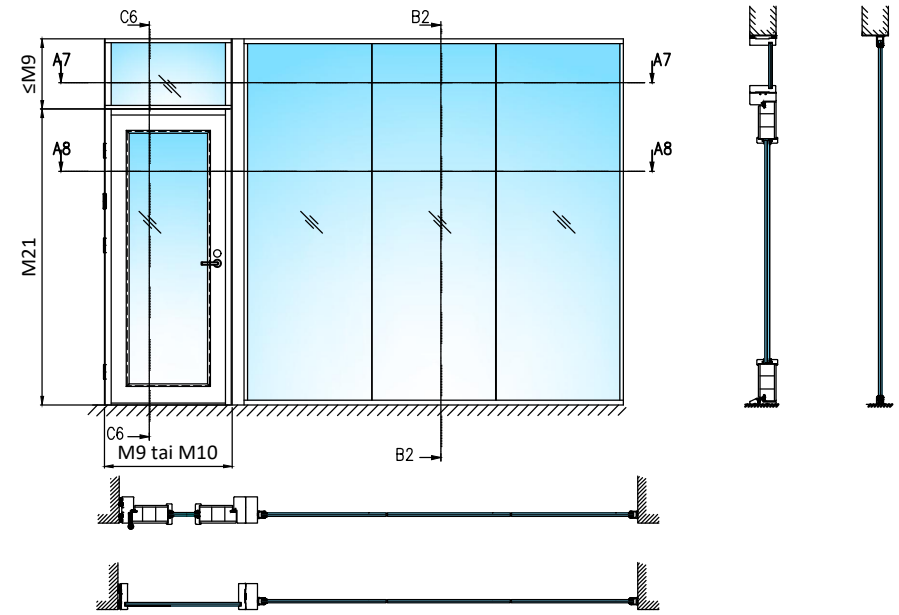
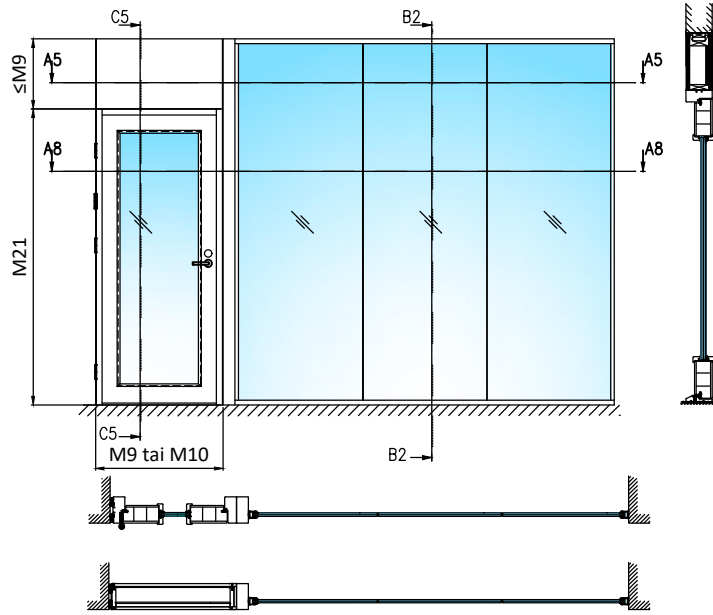
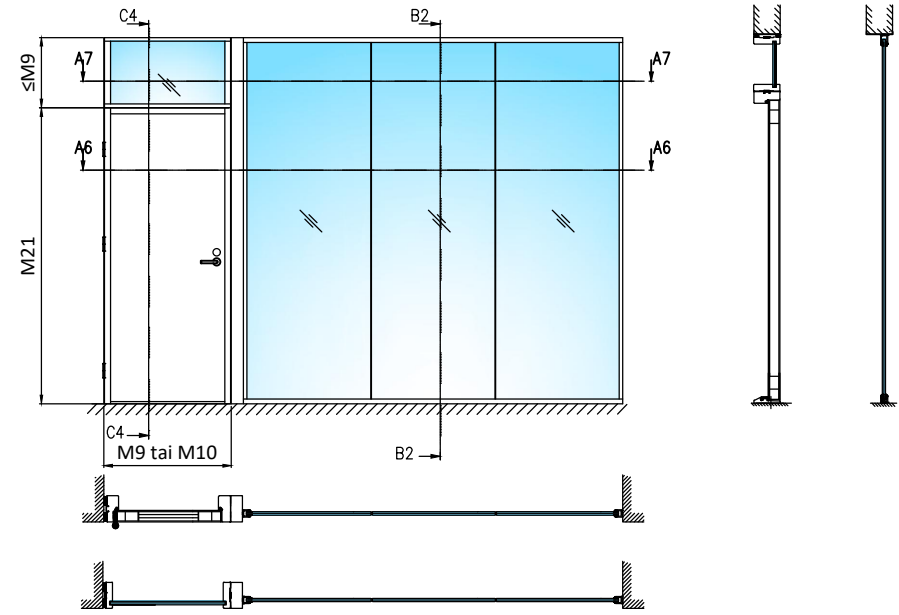
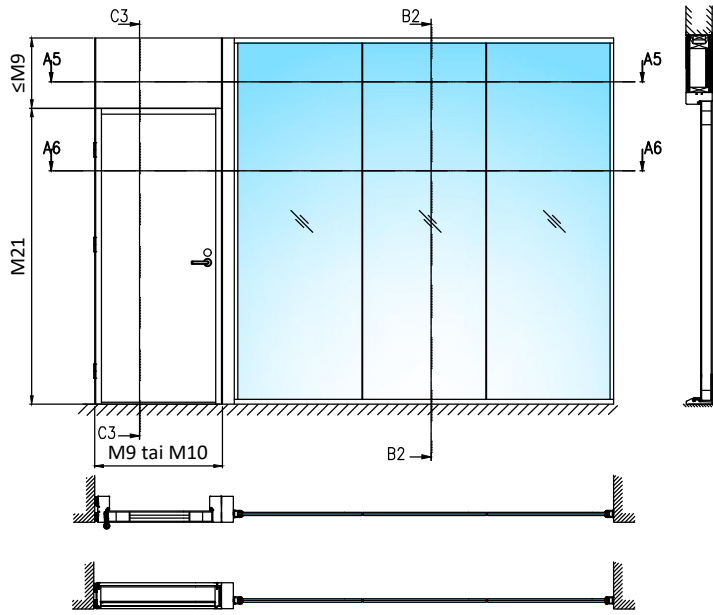

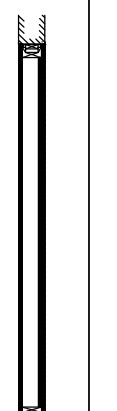
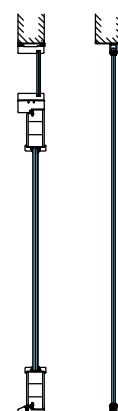
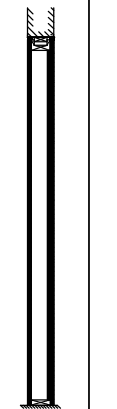
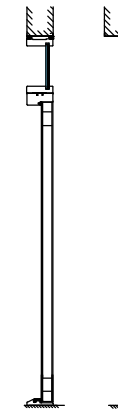
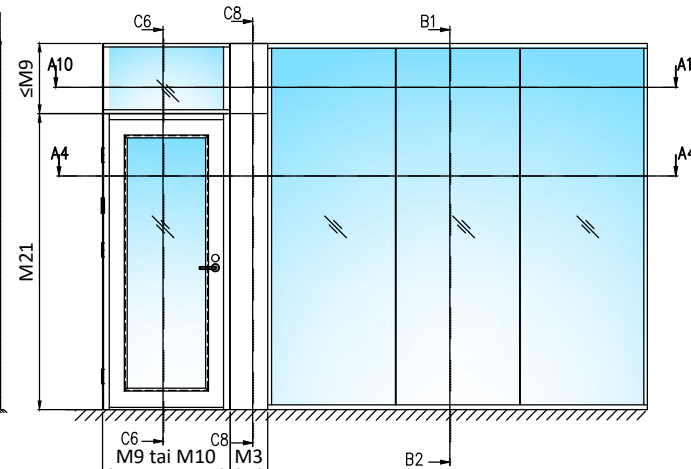
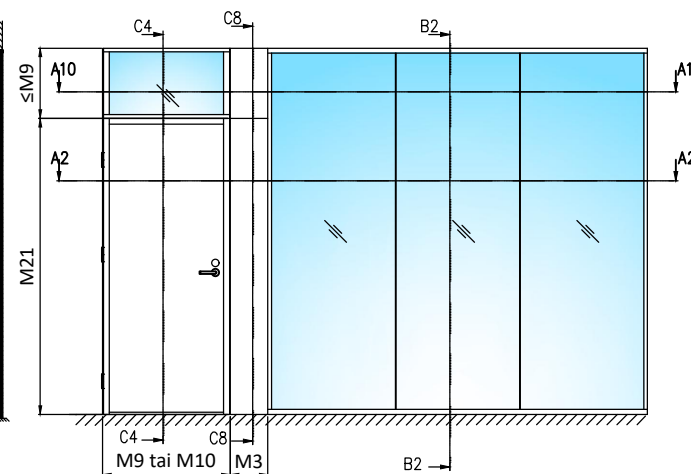
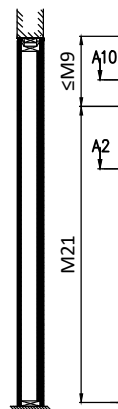
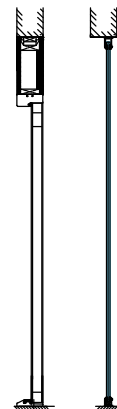
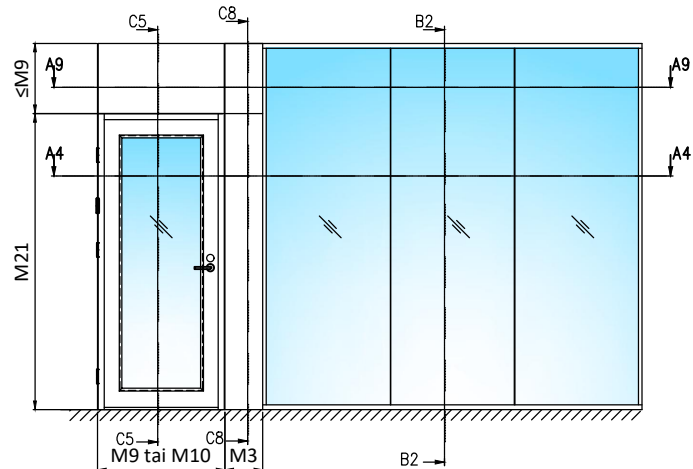
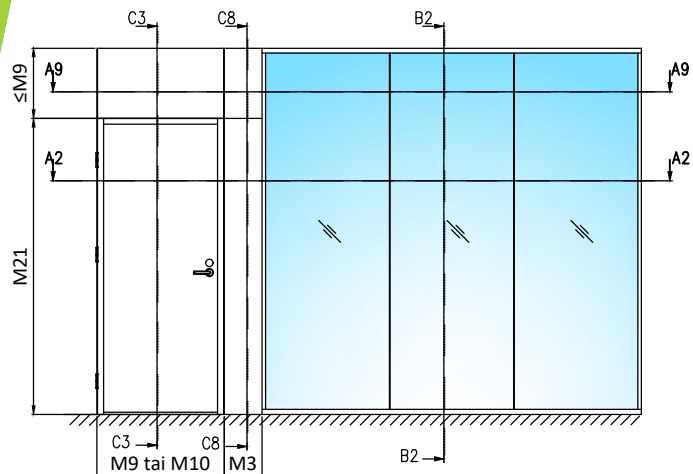

Pystyleikkaukset

- M9 (M10)x21 ulosaukeava umpiovi/
lasiukollinen ovi
- Karmi 42x92 mm
- Sisäänaukeava ovi peilikuvana
- Huom! Alas laskeutuva kynnyks -1dB

- Otsarakenteen sisään riittävä tukirakenne
oven/seinärakenteen kiinnitystä varten

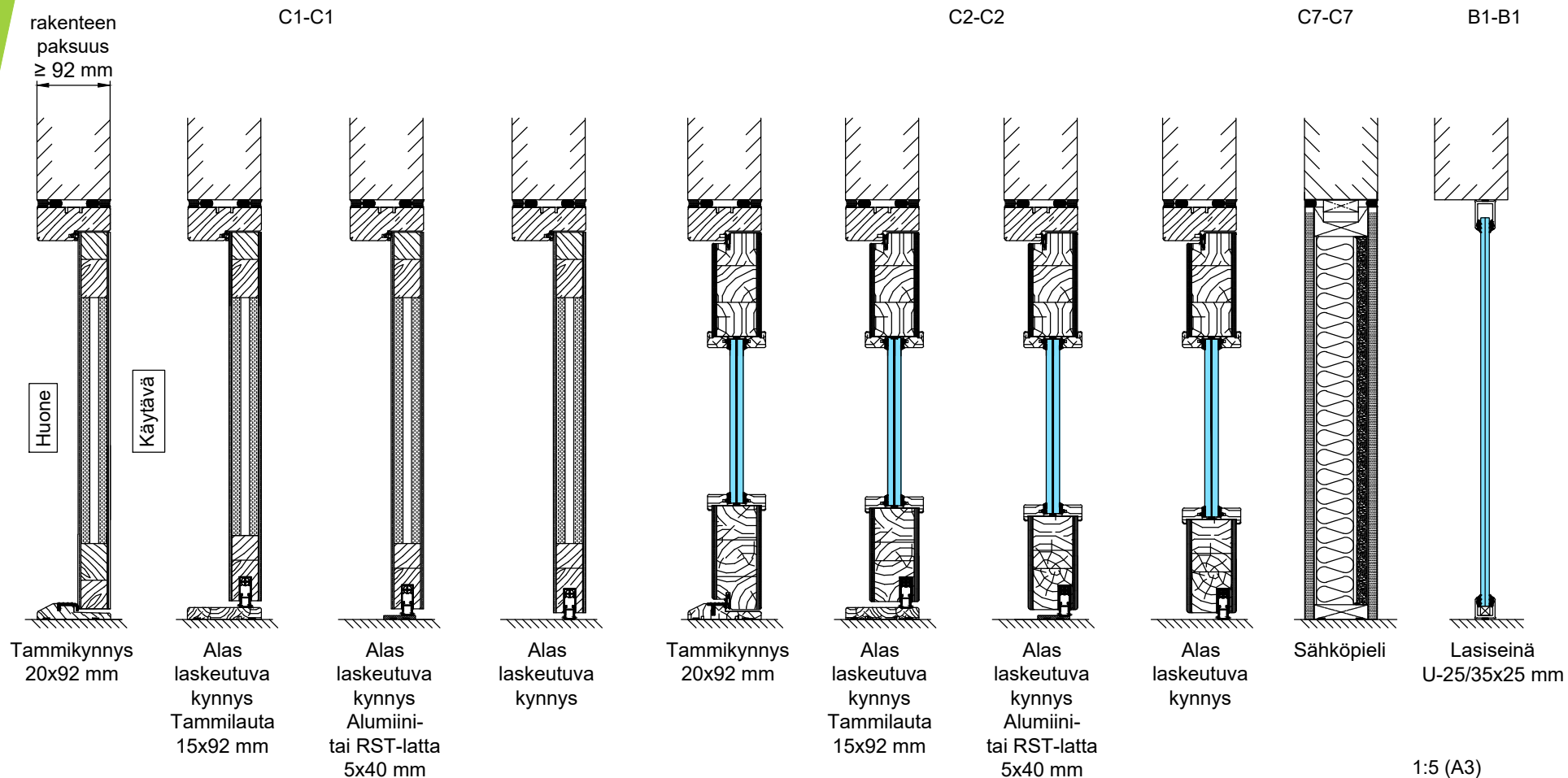

Pystyleikkaukset

- M9 (M10)x21 sisäänaukeava umpiovi/
lasiukollinen ovi
- L-karmi 42x92 mm
- Ulosaukeava ovi peilikuvana
- Huom! Alas laskeutuva kynnys -1dB

- Otsarakenteen sisään riittävä tukirakenne
oven/seinä rakenteen kiinnitystä varten

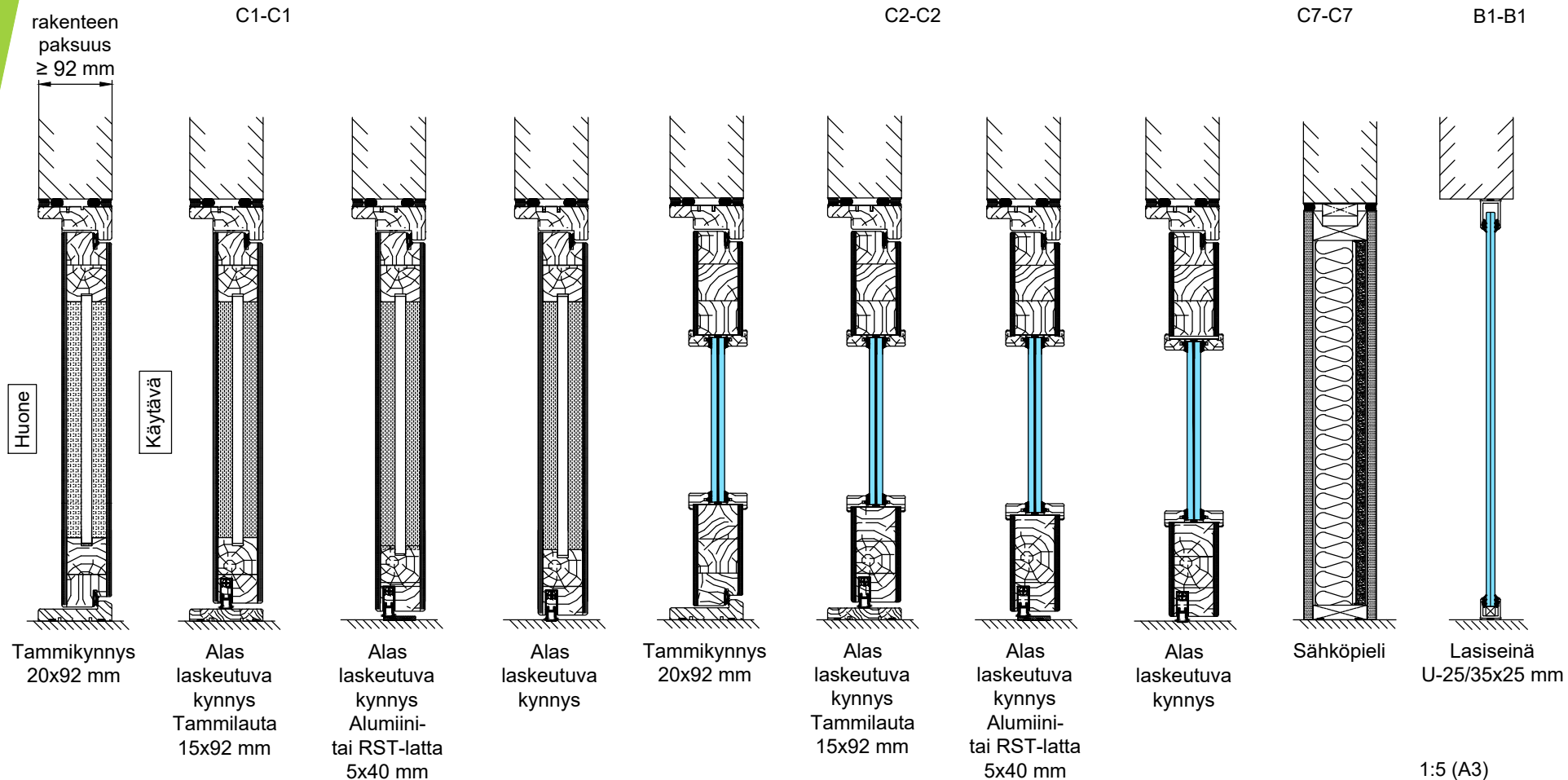

1:5 (A3)

Pystyleikkaukset

- M9 (M10)x21 ulosaukeava umpiovi umpi- ja lasiylösalla
- Karmi 42x92 mm
- Sisäänaukeava ovi peilikuvana
- Huom! Alas laskeutuva kynnyks -1dB

- Otsarakenteen sisään riittävä tukirakenne oven/seinärakenteen kiinnitystä varten

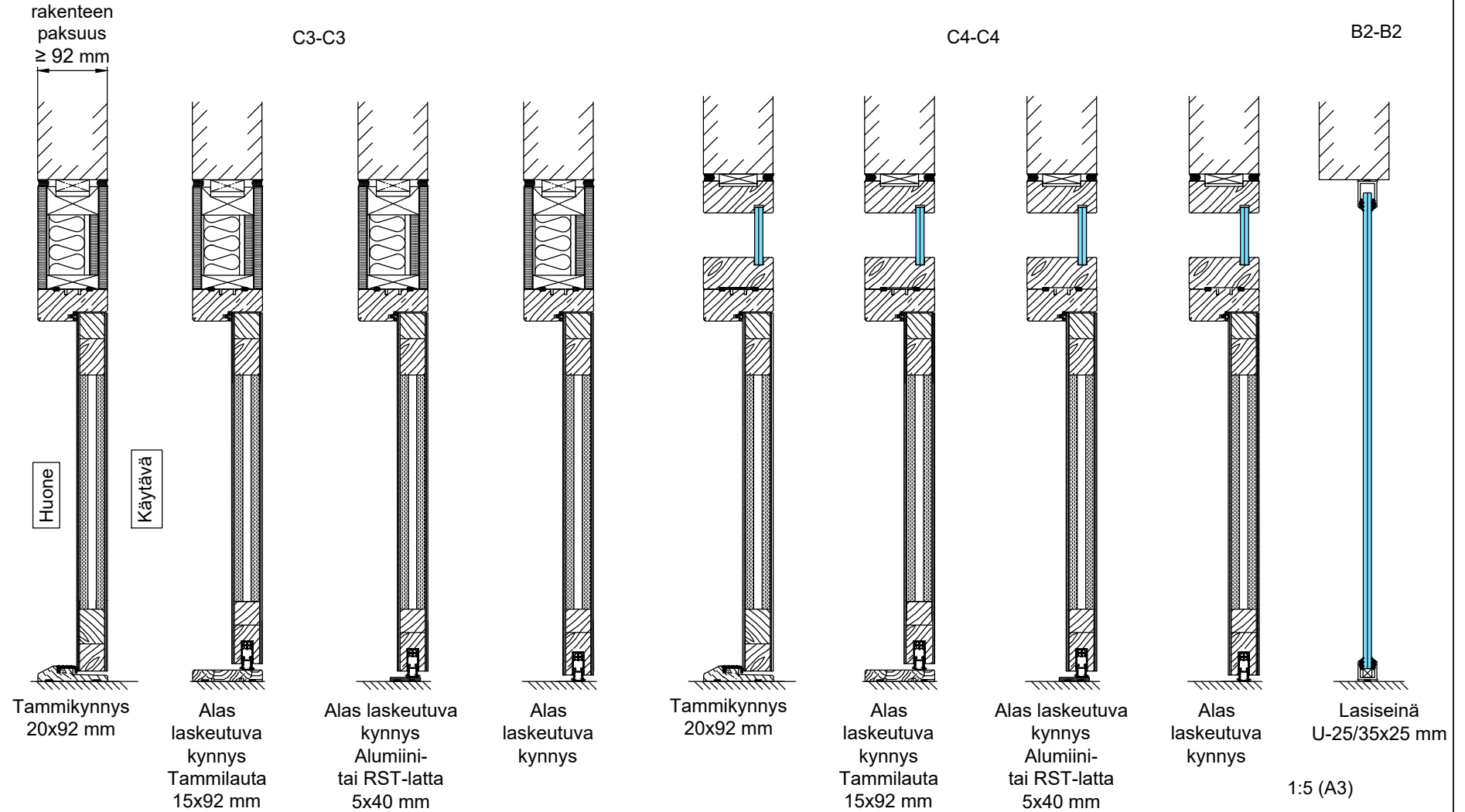

Pystyleikkaukset

- M9 (M10)x21 ulosaukeava umpiovi umpi- ja lasiyläosalla
- L-karmi 42x92 mm
- Sisäänaukeava ovi peilikuvana
- Huom! Alas laskeutuva kynnyks -1dB

- Otsarakenteen sisään riittävä tukirakenne oven/seinärakenteen kiinnitystä varten

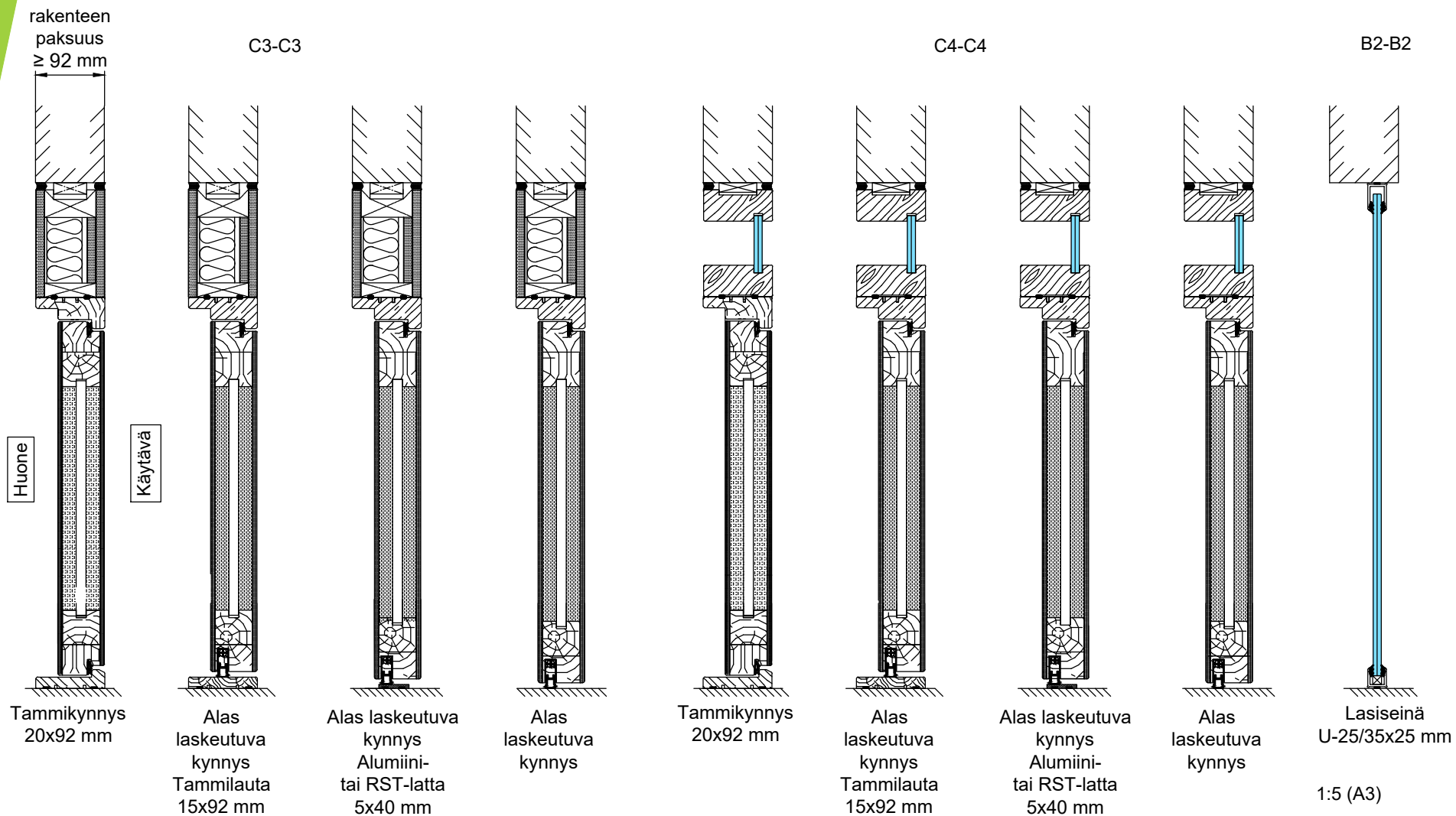

Pystyleikkaukset

- M9 (M10)x21 ulosaukeava lasiaukollinen ovi umpi- ja lasiyläosalla
- Karmi 42x92 mm
- Sisäänaukeava ovi peilikuvana
- Huom! Alas laskeutuva kynnys -1dB

- Otsarakenteen sisään riittävä tukirakenne oven/seinä rakenteen kiinnitystä varten

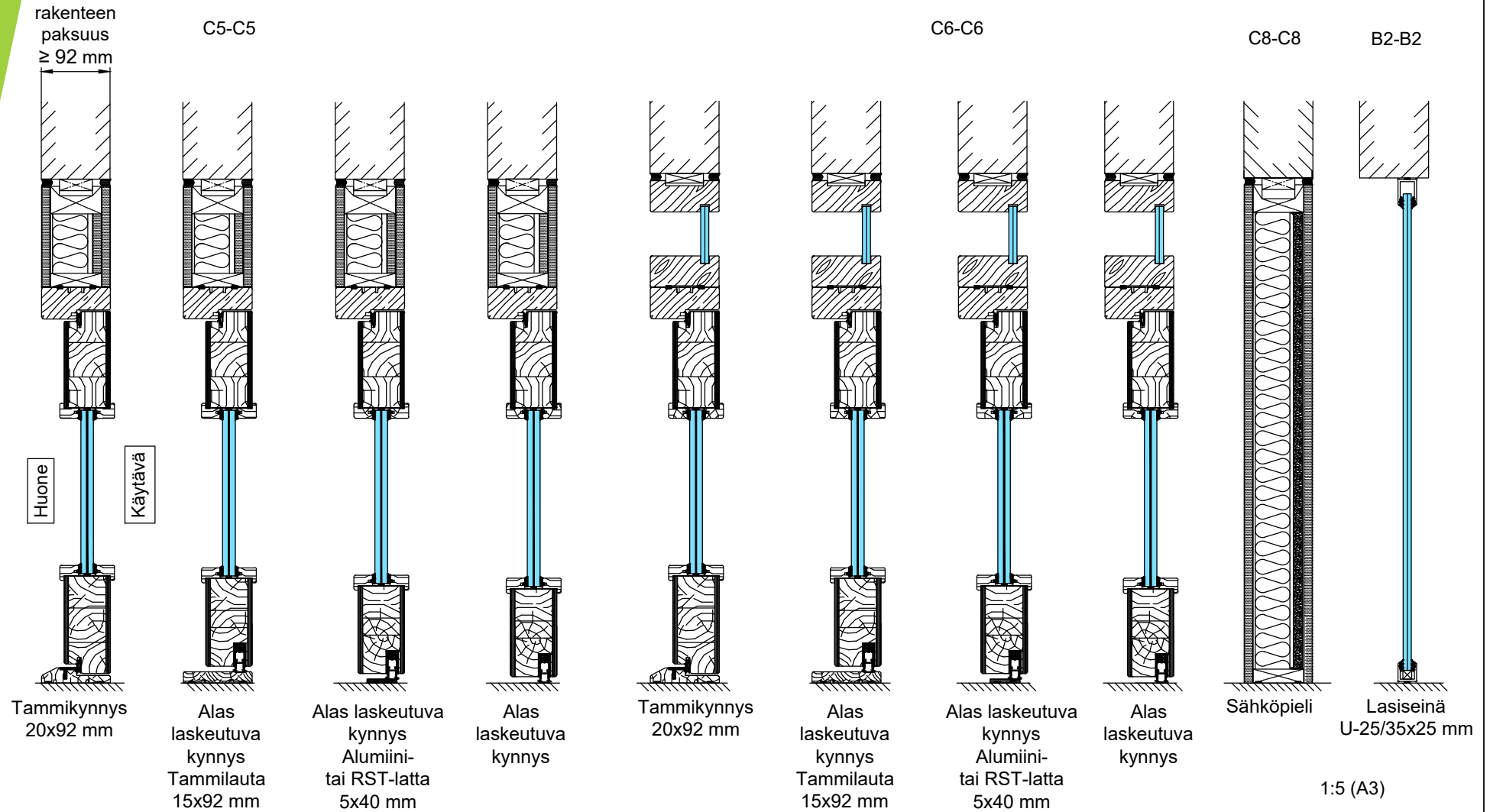

Pystyleikkaukset

- M9 (M10)x21 ulosaukeava lasiaukollinen ovi umpi- ja lasiyläosalla
- L-karmi 42x92 mm
- Sisäänaukeava ovi peilikuvana
- Huom! Alas laskeutuva kynnyks -1dB

- Otsarakenteen sisään riittävä tukirakenne oven/seinärakenteen kiinnitystä varten

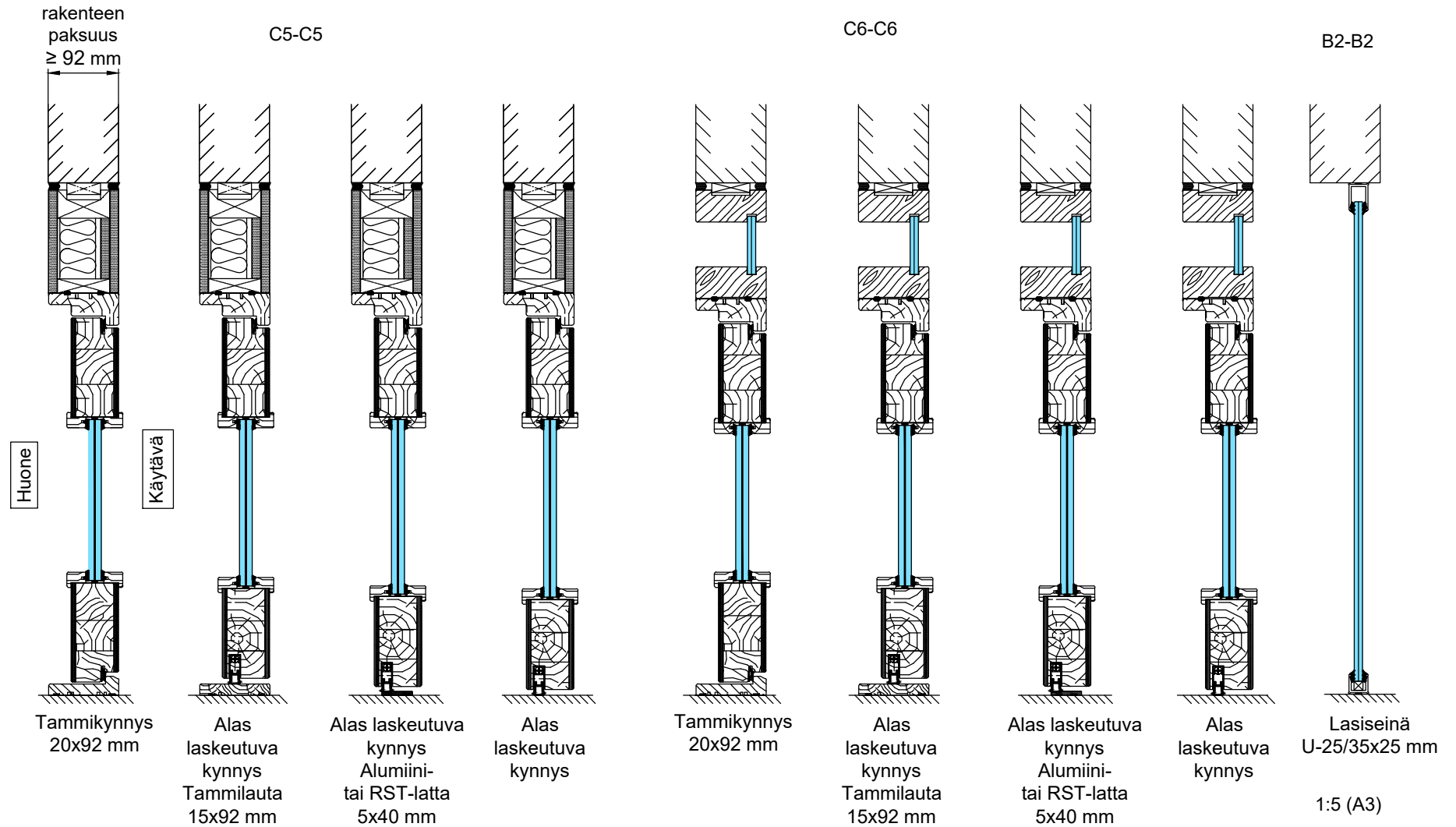

Vaakaleikkaukset

- M9 (M10)x21 umpiovi
- Karmi 42x92 mm
- Ympäröivän seinärakenteen sisään riittävä tukirakenne oven/seinärakenteen kiinnitystä varten

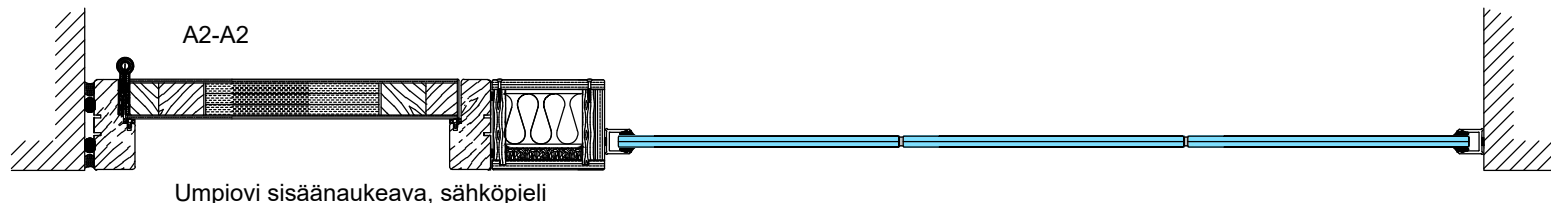
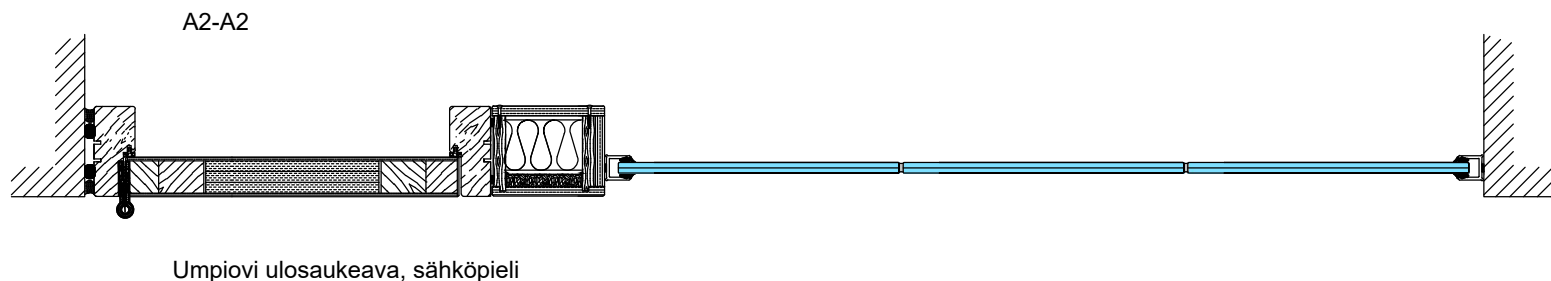
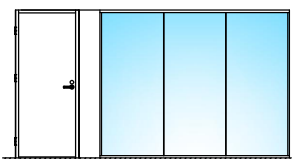
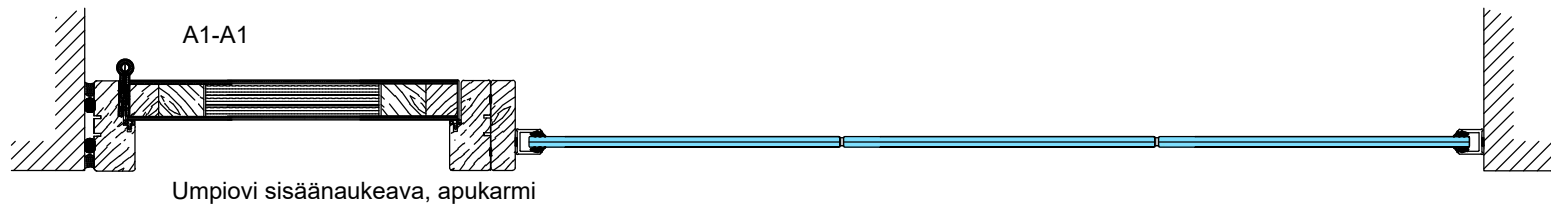
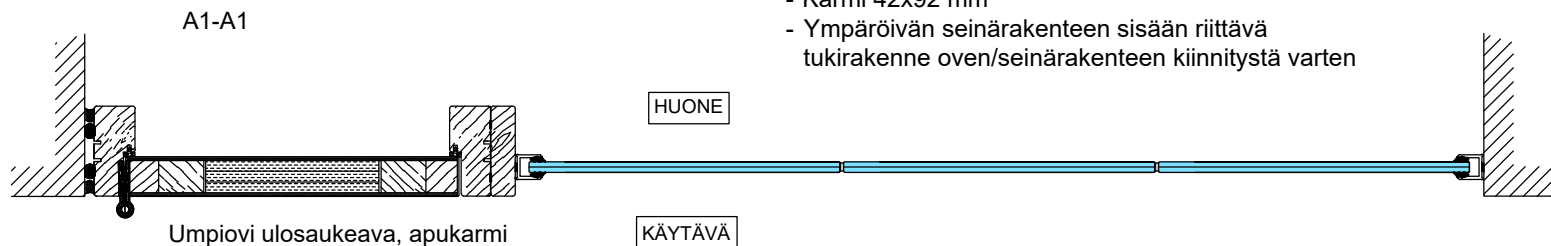
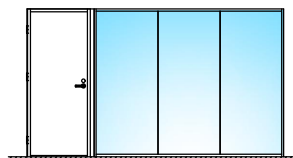

1:5 (A3)

Vaakaleikkaukset

- M9 (M10)x21 umpiovi umpi- tai lasiyläosalla
- Karmi 42x92 mm
- Ympäröivän seinärakenteen sisään riittävä tukirakenne oven/seinärakenteen kiinnitystä varten

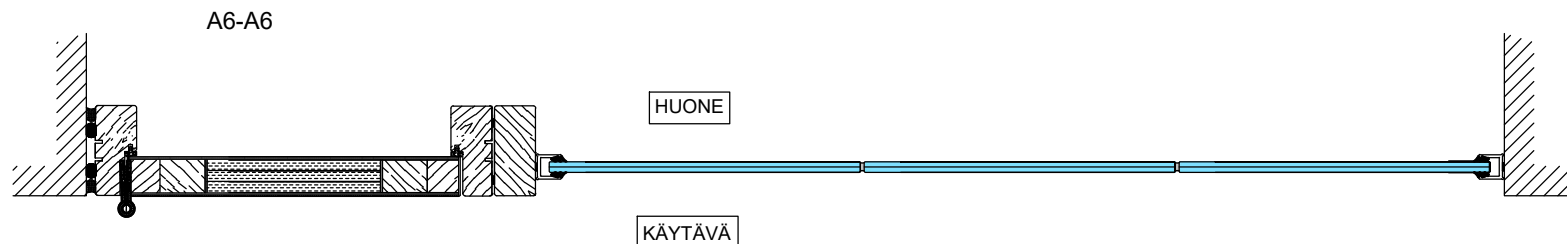
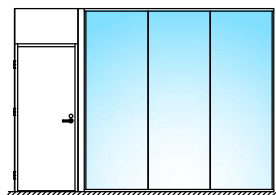

Umpiovi ulosaukeva, apukarmi

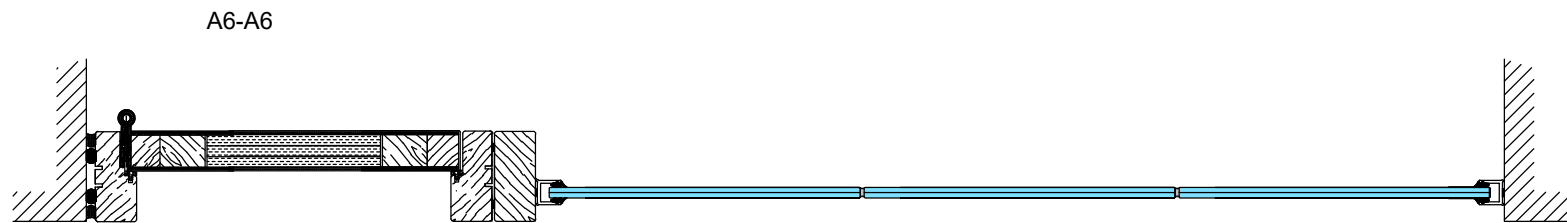
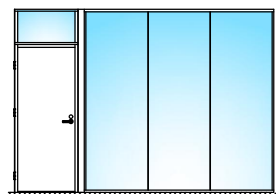

Umpiovi sisäänaukeva, apukarmi

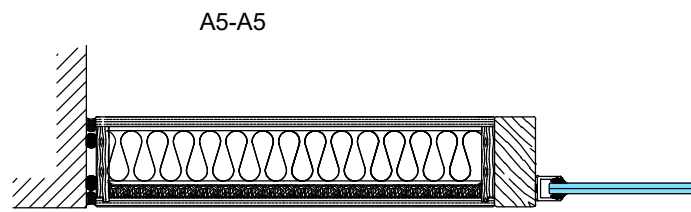

Oven umpiyläosa

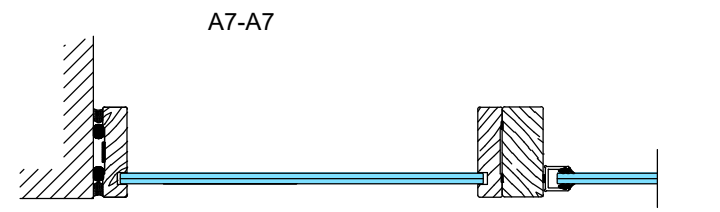

Oven lasiyläosa

1:5 (A3)

Vaakaleikkaukset

- M9 (M10)x21 umpiovi umpi- tai lasiyläosalla
- Karmi 42x92 mm
- Ympäröivän seinärakenteen sisään riittävä tukirakenne oven/seinärakenteen kiinnitystä varten

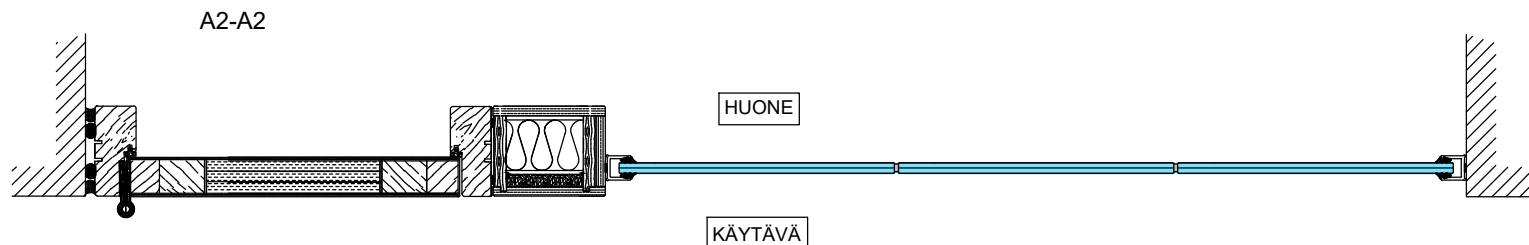
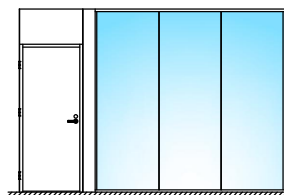

Umpiovi ulosaukeva, sähköpieli

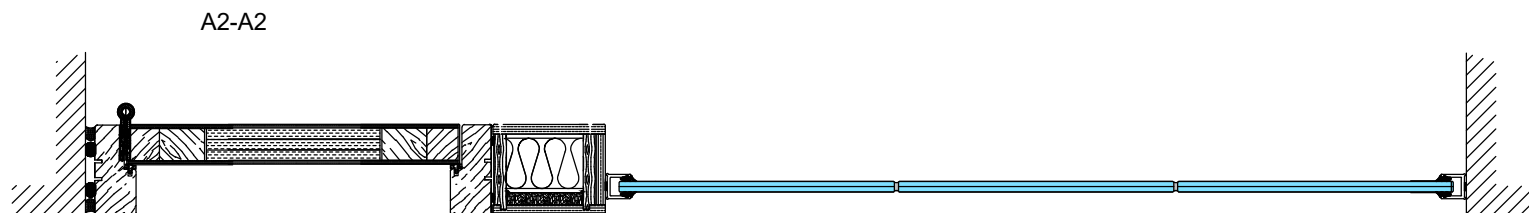
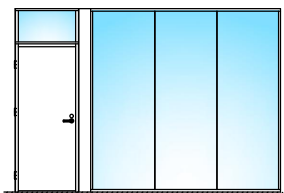

Umpiovi sisäänaukeva, sähköpieli

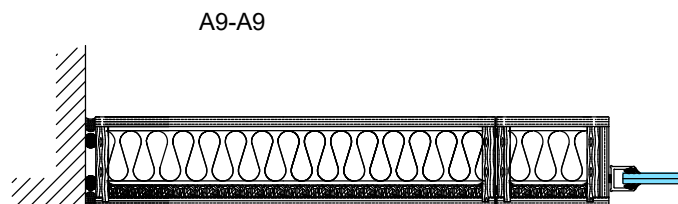

Oven umpiyläosa

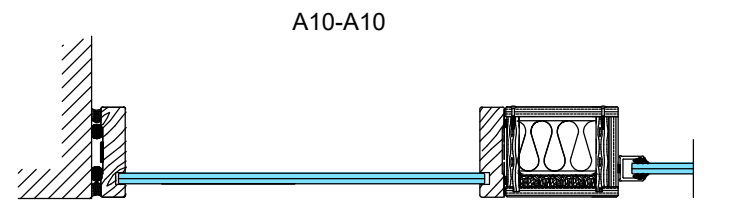

Oven lasiyläosa

1:5 (A3)

Vaakaleikkaukset

- M9 (M10)x21 umpiovi
- L-karmi 42x92 mm
- Ympäröivän seinärakenteen sisään riittävä tukirakenne oven/seinärakenteen kiinnitystä varten

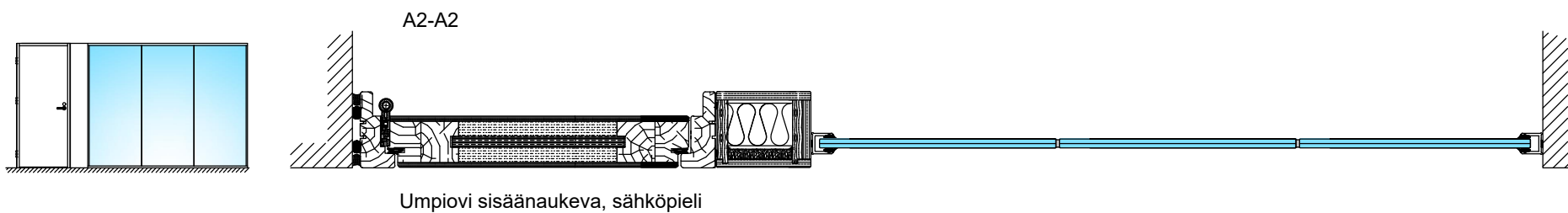
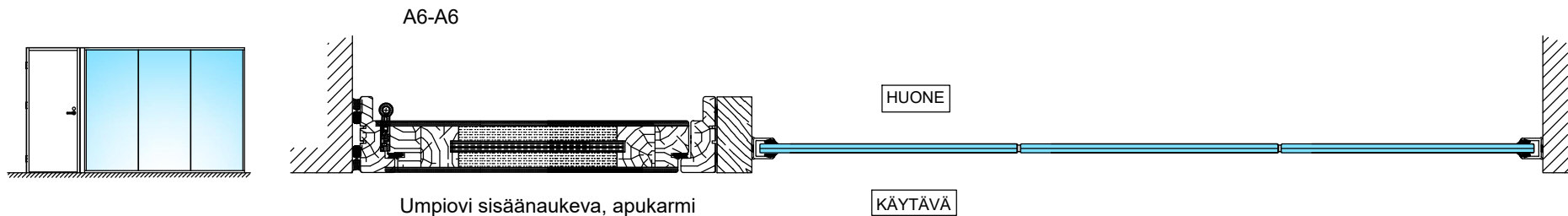

1:5 (A3)

Vaakaleikkaukset

- M9 (M10)x21 umpiovi
- L-karmi 42x92 mm
- Ympäröivän seinärakenteen sisään riittävä tukirakenne oven/seinärakenteen kiinnitystä varten

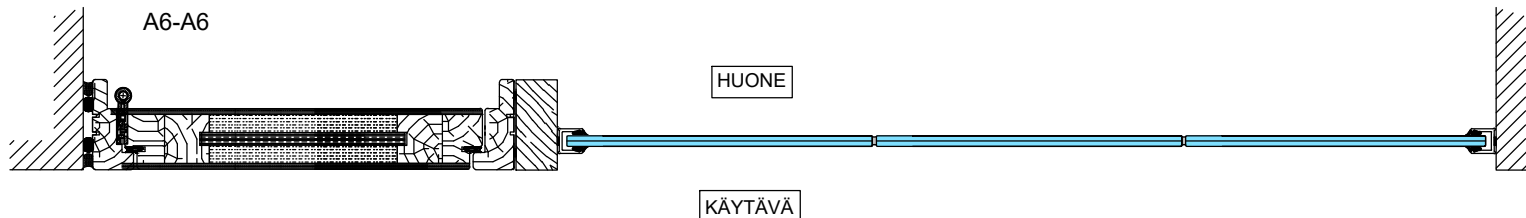
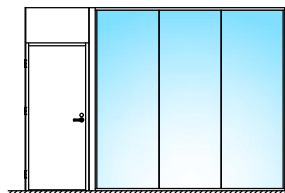

Umpiovi sisäänaukeava, apukarmi

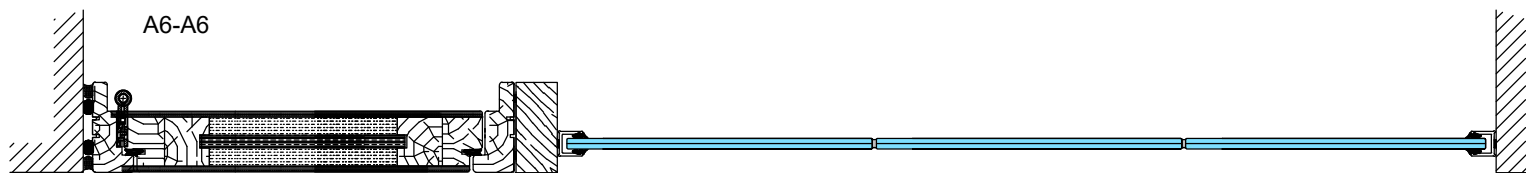
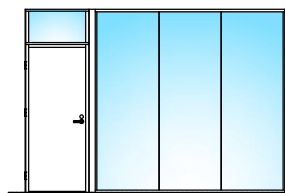

Umpiovi sisäänaukeava, apukarmi

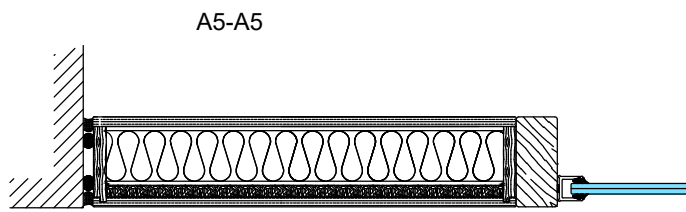

Oven umpiyläosa

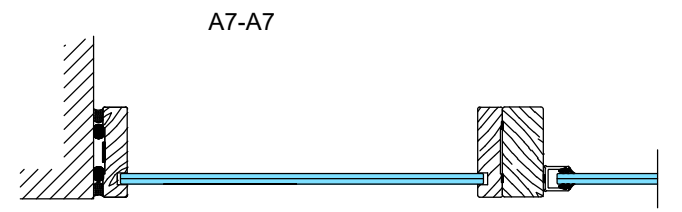

Oven lasiyläosa

1:5 (A3)

- M9 (M10)x21 umpiovi
- L-karmi 42x92 mm
- Ympäröivän seinärakenteen sisään riittävä tukirakenne oven/seinärakenteen kiinnitystä varten

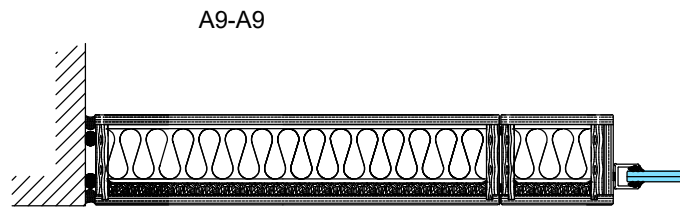
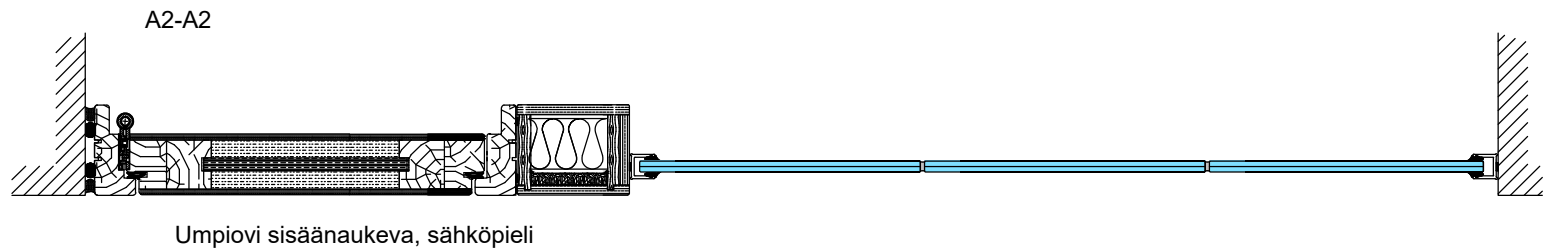
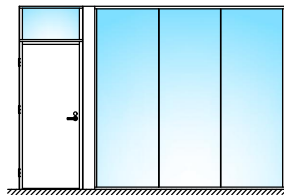
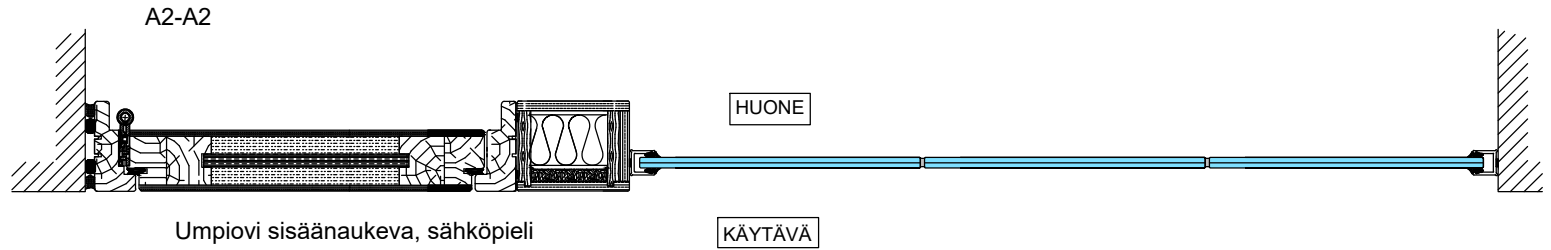
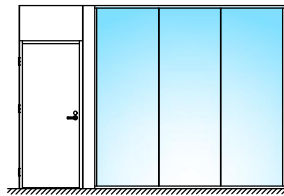

Oven umpiyläosa

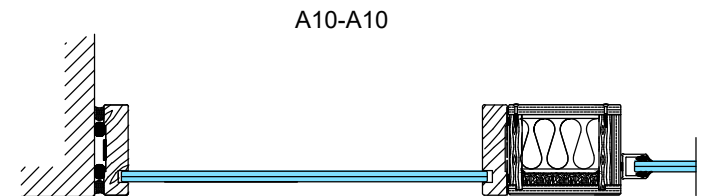

Oven lasiyläosa

1:5 (A3)

Vaakaleikkaukset

- M9 (M10)x21 lasiaukollinen ovi
- Karmi 42x92 mm
- Ympäröivän seinärakenteen sisään riittävä tukirakenne oven/seinärakenteen kiinnitystä varten

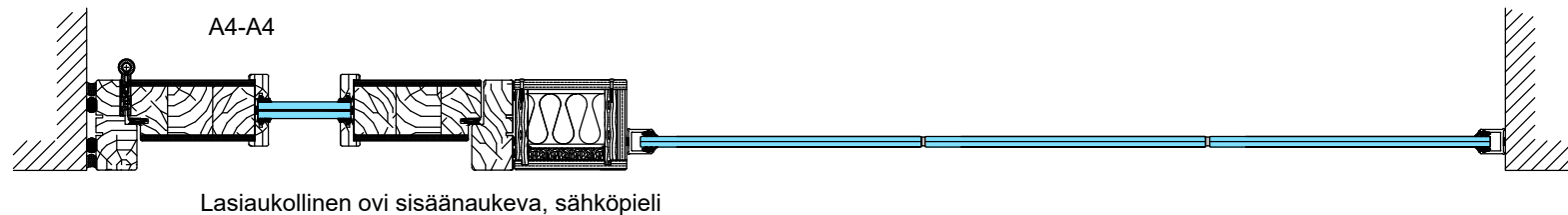
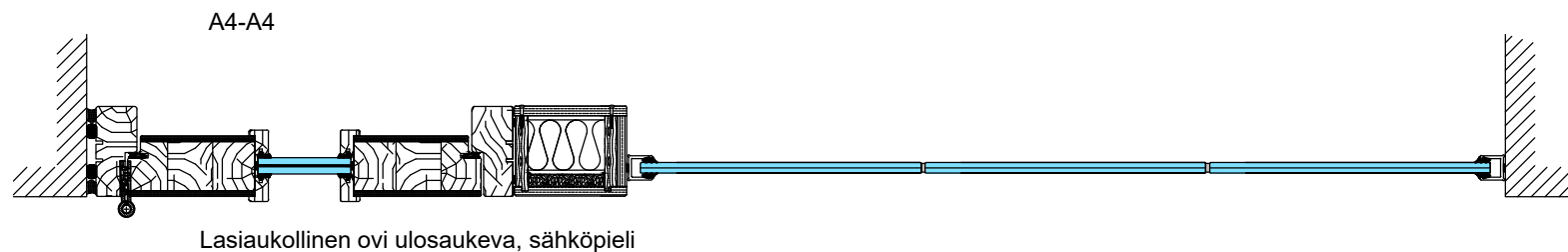
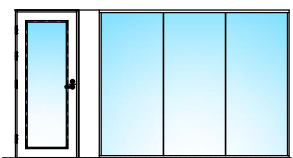
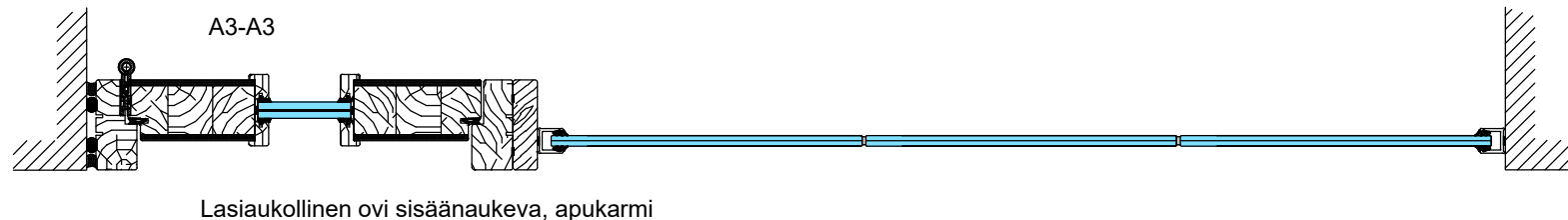
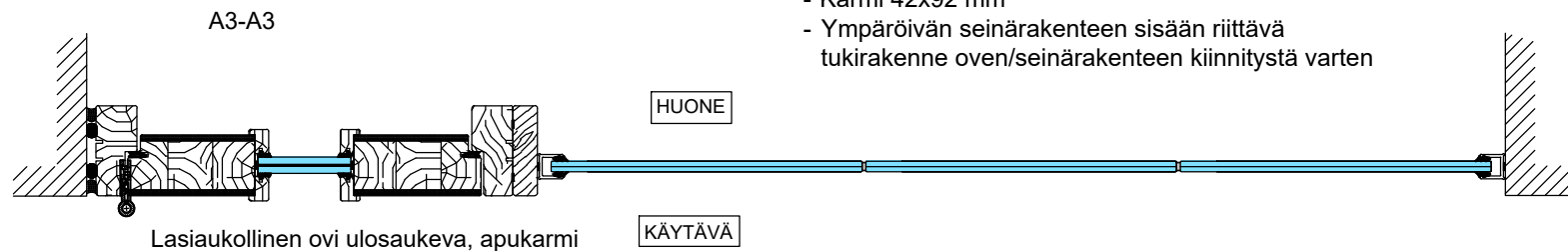
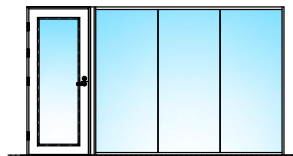

1:5 (A3)

Vaakaleikkaukset

- M9 (M10)x21 lasiaukollinen ovi umpi- tai lasiyläosalla
- Karmi 42x92 mm
- Ympäröivän seinärakenteen sisään riittävä tukirakenne oven/seinärakenteen kiinnitystä varten

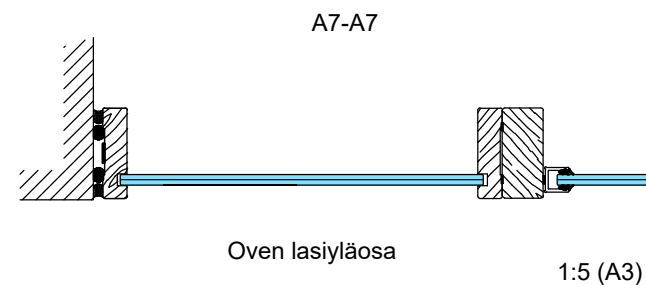
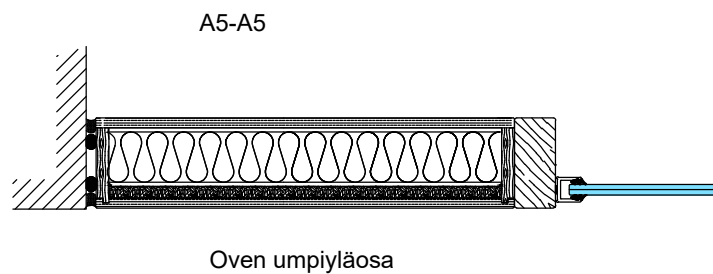
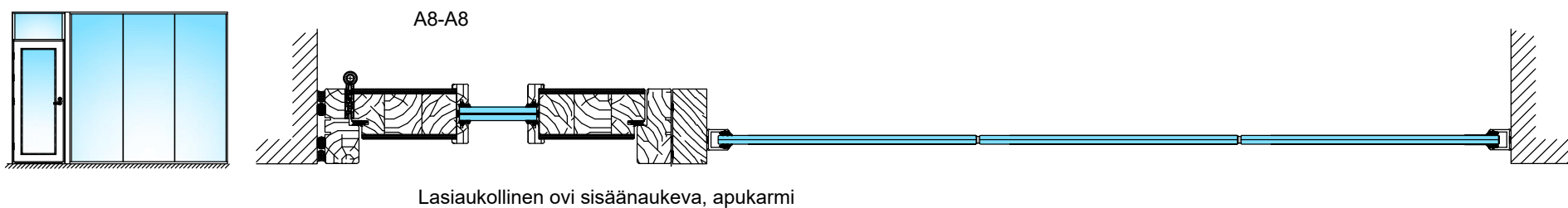
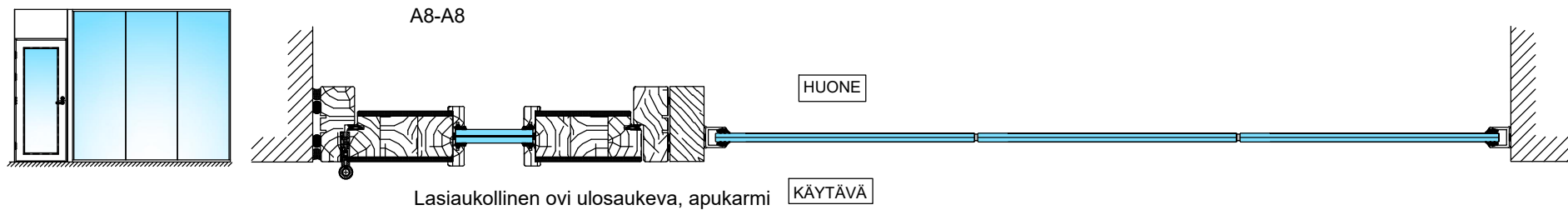

Vaakaleikkaukset

- M9 (M10)x21 lasiaukollinen ovi umpi- tai lasiyläosalla
- Karmi 42x92 mm
- Ympäröivän seinärakenteen sisään riittävä tukirakenne oven/seinärakenteen kiinnitystä varten

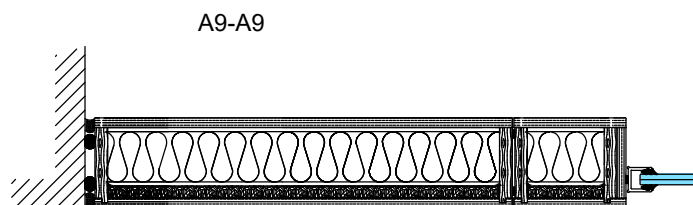
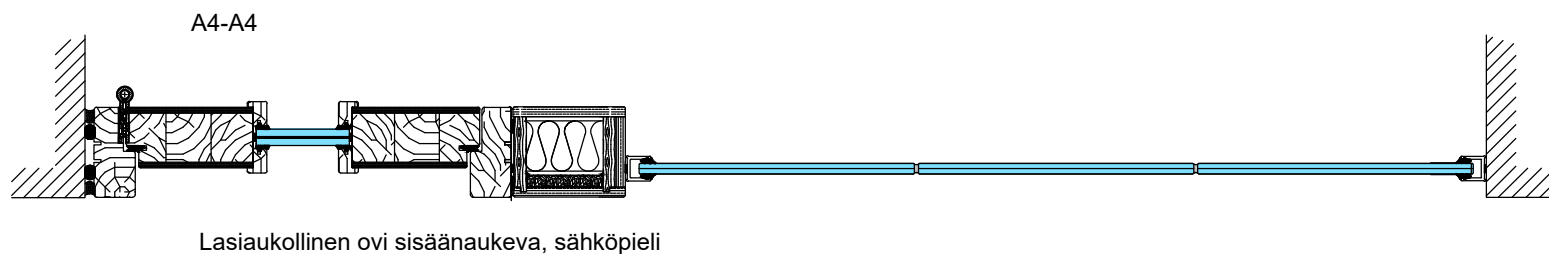
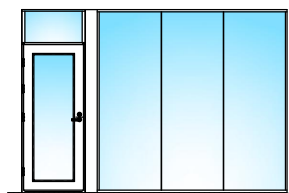
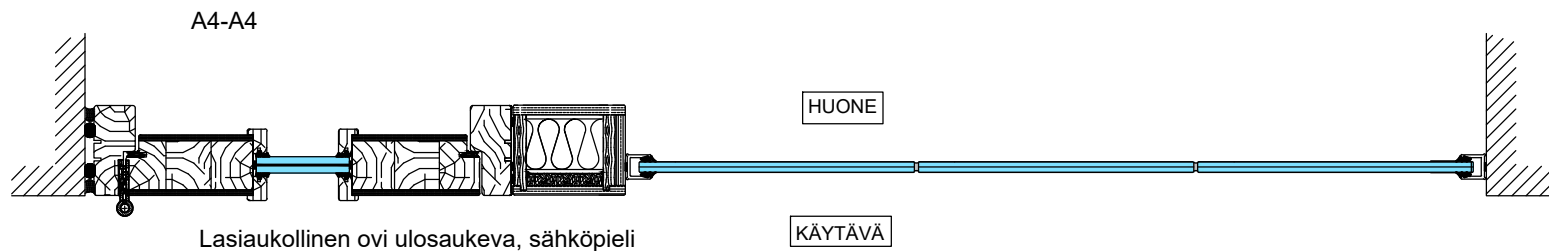
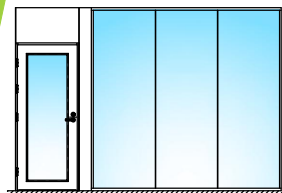

Oven umpiyläosa

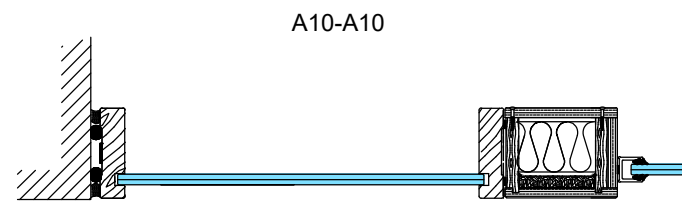

1:5 (A3)

Vaakaleikkaukset

- M9 (M10)x21 umpiovi
- L-karmi 42x92 mm
- Ympäröivän seinärakenteen sisään riittävä tukirakenne oven/seinärakenteen kiinnitystä varten

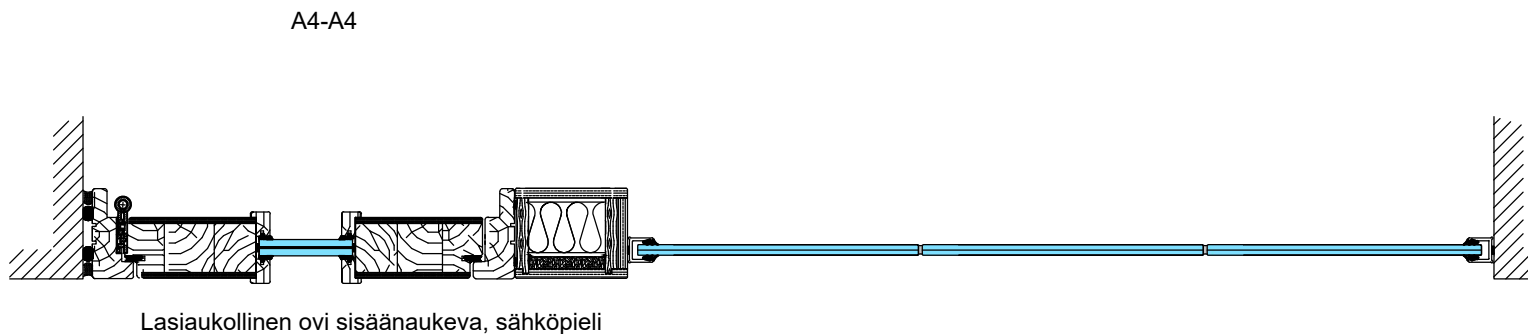
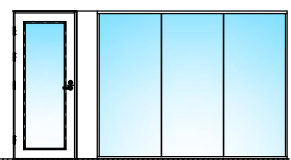
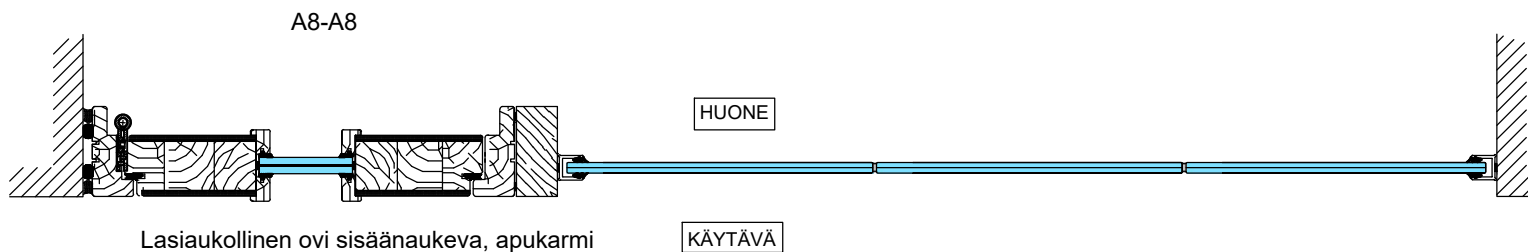
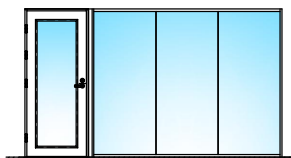

1:5 (A3)

Vaakaleikkaukset

- M9 (M10)x21 umpiovi
- L-karmi 42x92 mm
- Ympäröivän seinärakenteen sisään riittävä tukirakenne oven/seinärakenteen kiinnitystä varten

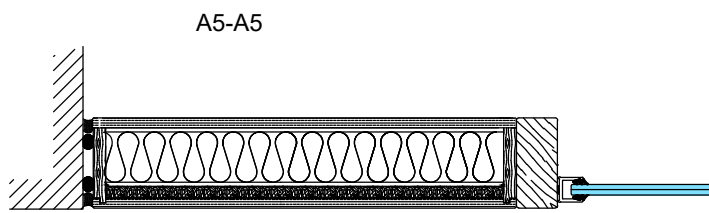
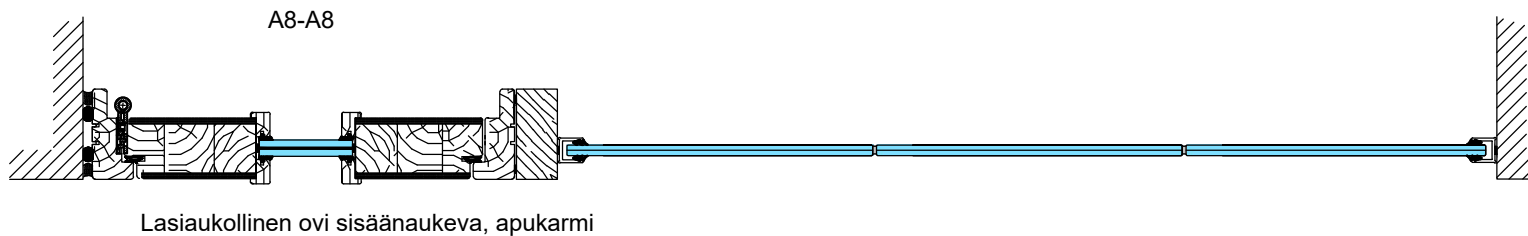
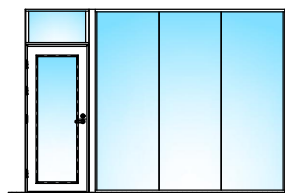
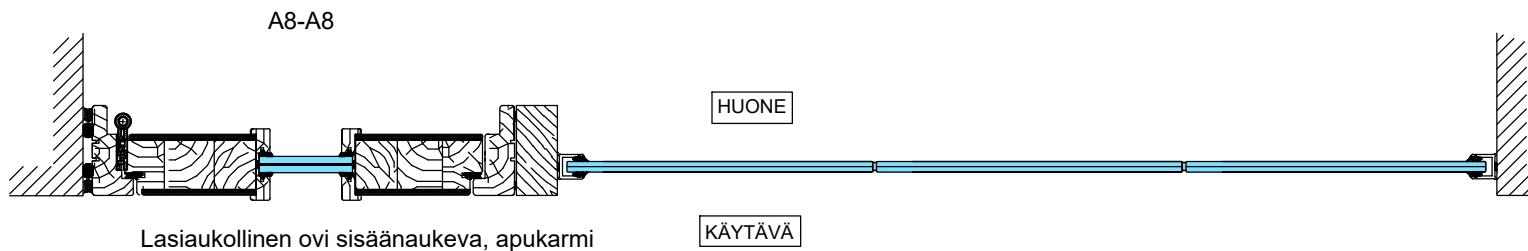
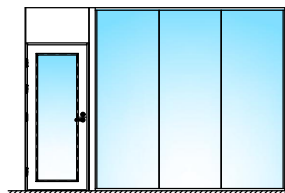

Oven umpiyläosa

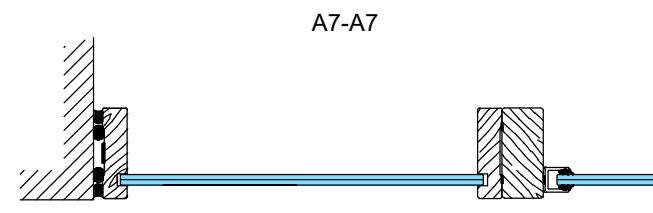

Oven lasiyläosa

1:5 (A3)

Vaakaleikkaukset

- M9 (M10)x21 umpiovi
- L-karmi 42x92 mm
- Ympäröivän seinärakenteen sisään riittävä tukirakenne oven/seinärakenteen kiinnitystä varten

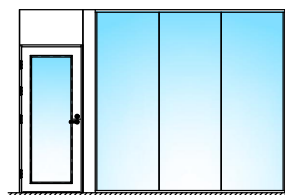

A4-A4

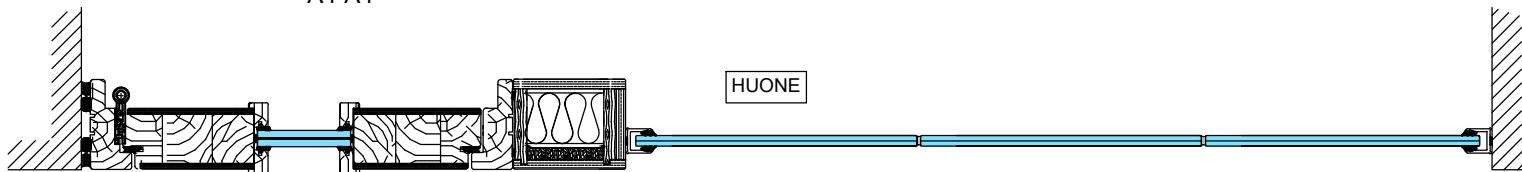

Lasiukollinen ovi sisäänaukeava, sähköpieli

KÄYTÄVÄ

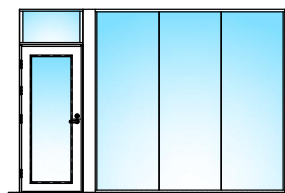

A4-A4

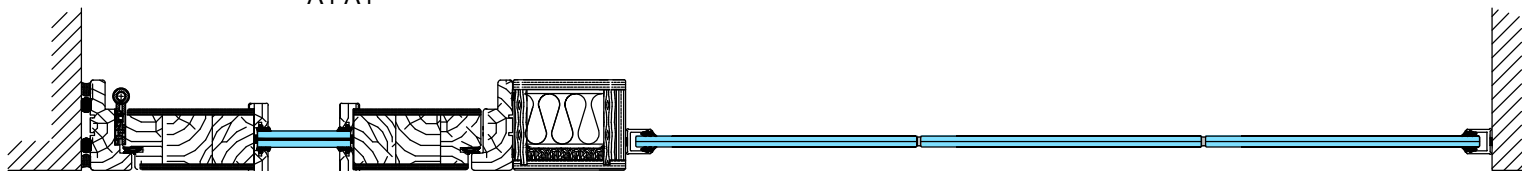

Lasiukollinen ovi sisäänaukeava, sähköpieli

A9-A9

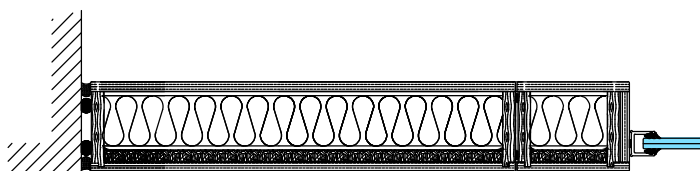

Oven umpiyläosa

A10-A10



Oven lasiyläosa

1:5 (A3)